

4

3

2

1

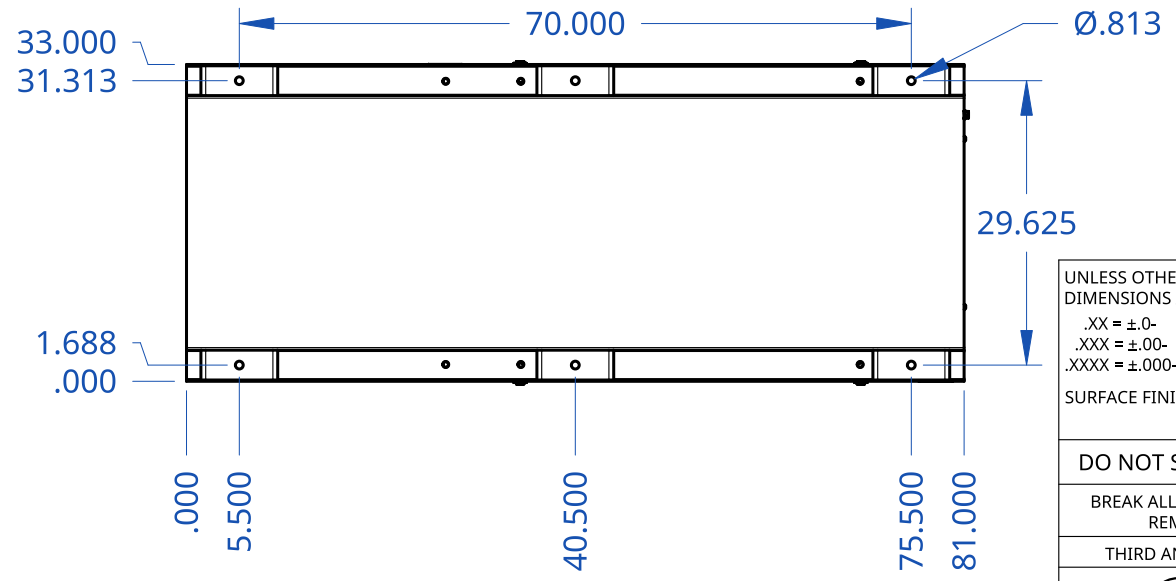
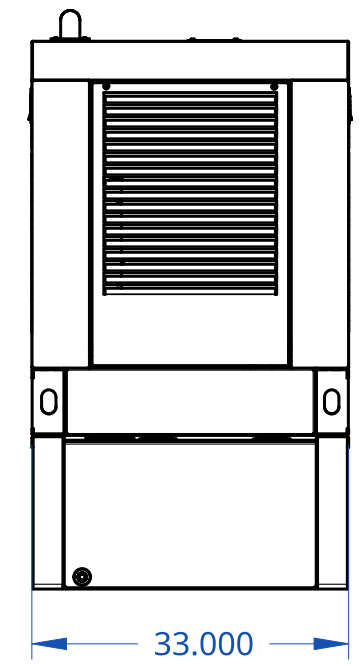
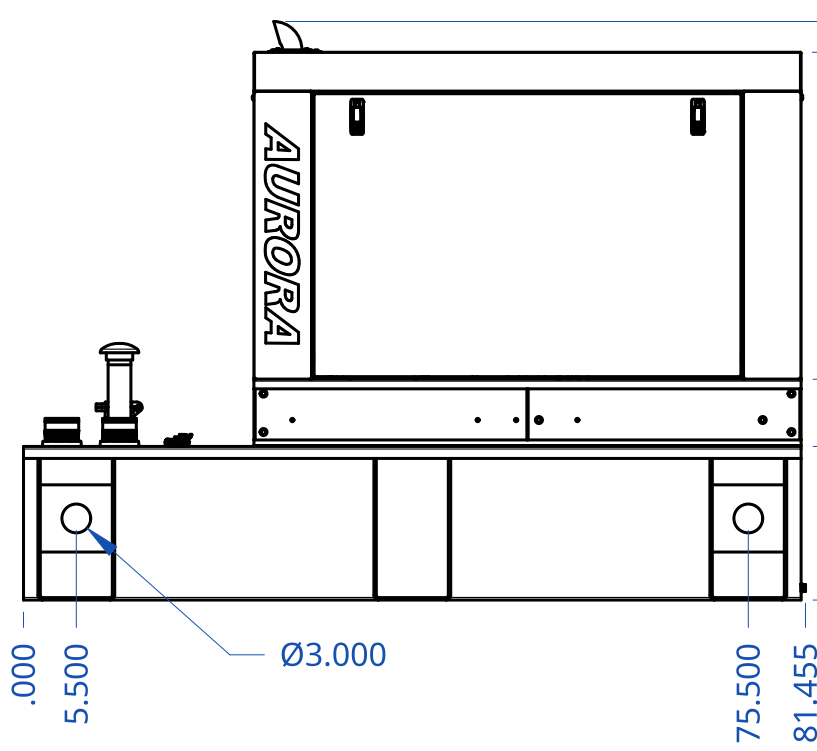
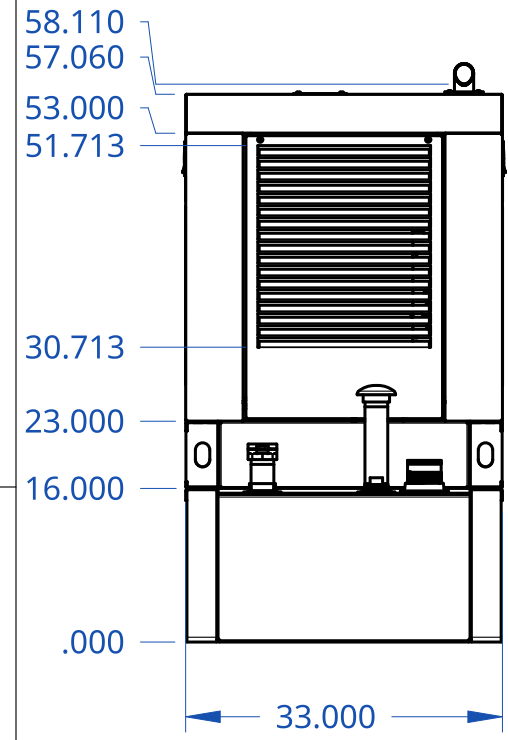
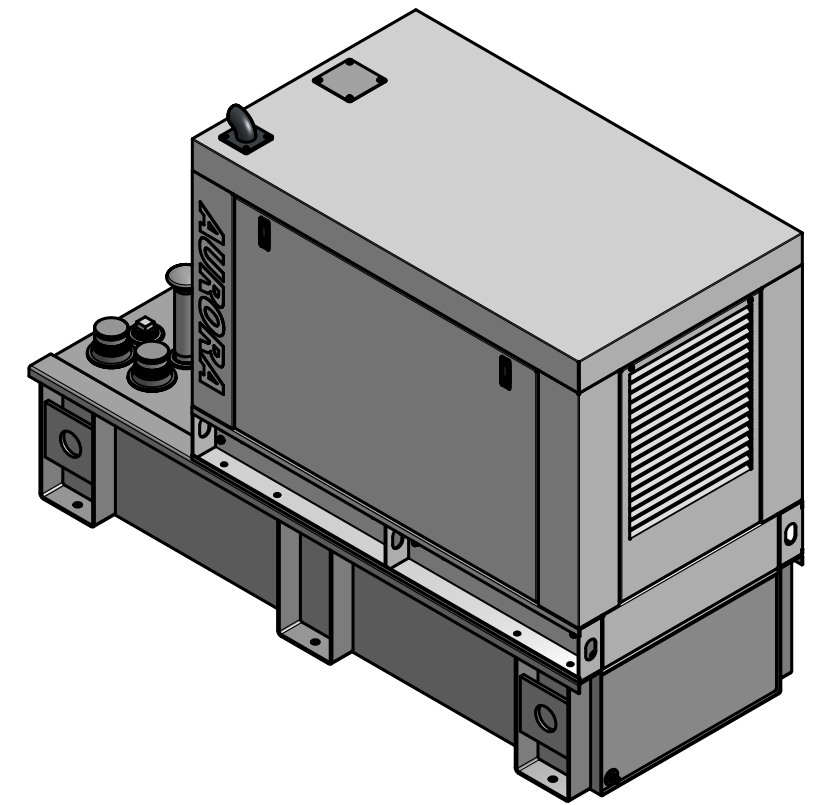
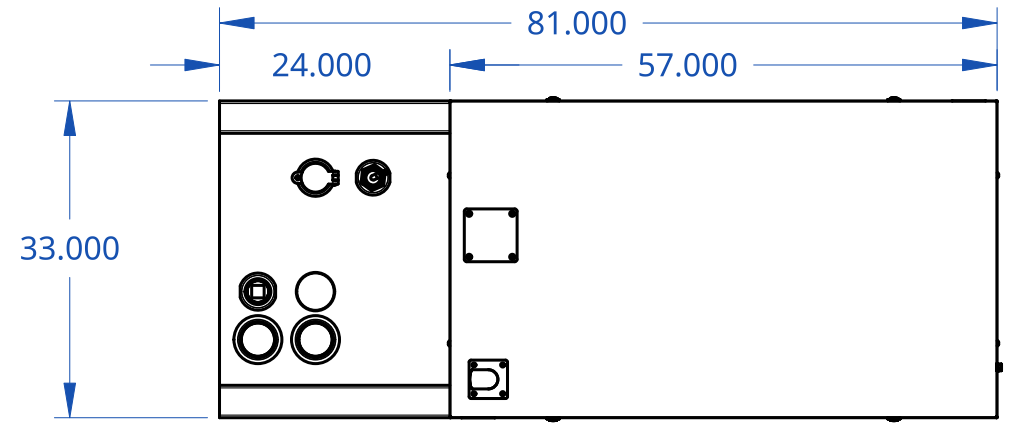

UNLESS OTHERWISE SPECIFIED,
DIMENSIONS ARE IN INCHES
.XX = ±.0-
.XXX = ±.00-
.XXXX = ±.000-
ANGULAR = ± °
FRACTIONAL = ±
SURFACE FINISH

DO NOT SCALE DRAWING
BREAK ALL SHARP EDGES AND
REMOVE BURRS
THIRD ANGLE PROJECTION

	NAME	DATE
DRAWN	Aurora	April 10 2024
CHECKED		
APPROVED		
MATERIAL	FINISH	

TITLE			SKU# AGI6Y-E-100 6 kW Yanmar Generator + 100 Gallon Tank Aurora Generators Inc.		
SIZE	DWG NO.	REV.			
B	AGI6Y-E-100-DWG01	D			
SCALE	WEIGHT	SHEET	1 of 1		

4

3

2

1

D

D

C

C

B

B

A

A